

SHARP®

COLOUR TELEVISION

MODEL

15JF-26H

■ OPERATION MANUAL ■

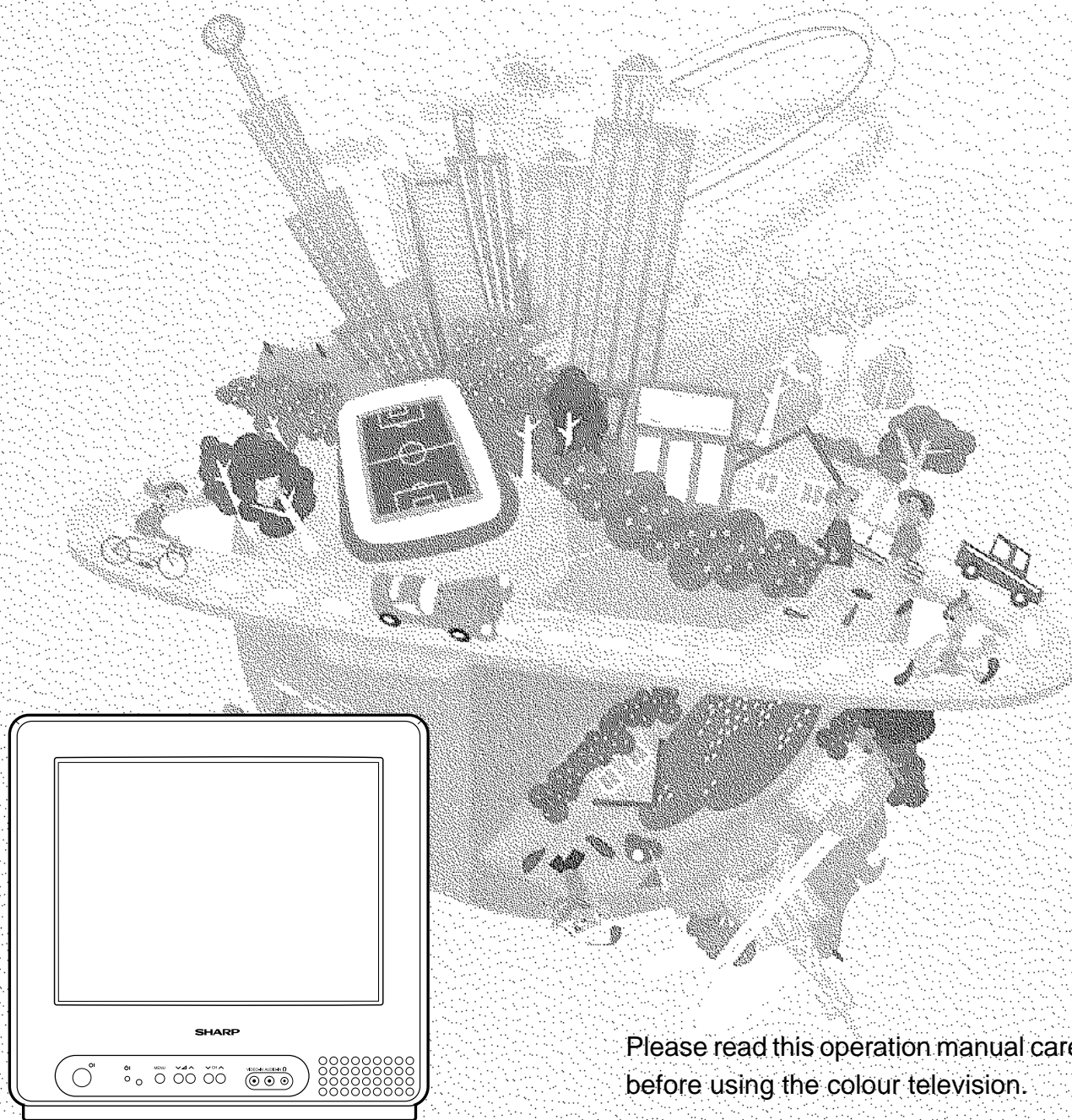

Please read this operation manual carefully
before using the colour television.



PRINTED ON ENVIRONMENTALLY FRIENDLY PAPER



TERMS OF GUARANTEE

Subject to the conditions listed below Sharp Electronics (U.K.) Ltd. (Hereinafter called <the Company>) guarantee to provide for the repair of, or at its option replace, Sharp Equipment, or any component thereof, (other than Batteries), which is faulty or below standard, as a result of inferior workmanship or materials.

The conditions of the guarantee are:

1. This guarantee shall only apply to defects or faults which are notified to the Company, or its approved Service Facility within one year from the date of purchase of the equipment.
2. This guarantee covers equipment intended for private domestic use only. This guarantee does not apply to equipment used in the course of a business, trade or profession.
3. This guarantee does not cover any faults or defects caused by accident, misuse, fair wear and tear, neglect, tampering with the equipment, or any attempt at adjustment or repair other than by an approved Service Facility.
4. In the unlikely event of your equipment requiring repair, please contact the Dealer or Supplier from whom it was purchased. Where this is not possible please contact the **telephone number** listed below during normal office hours. You will then be given details of how to obtain service.
08705-274277
5. The cost of carriage to and from the Dealer, Supplier or Sharp approved Service Facility shall be borne by the purchaser.
6. No person has any authority to vary the terms or conditions of this guarantee.
7. This guarantee is offered as an additional benefit to the consumer's statutory rights and does not affect rights in any way.

SPECIAL NOTE FOR USERS IN THE U.K.

The mains lead of this product is fitted with a non-rewireable (moulded) plug incorporating a 3A fuse. Should the fuse need to be replaced, a BSI or ASTA approved BS 1362 fuse marked  or  and of the same rating as above, which is also indicated on the pin face of the plug, must be used.

Always refit the fuse cover after replacing the fuse. Never use the plug without the fuse cover fitted.

In the unlikely event of the socket outlet in your home not being compatible with the plug supplied, cut off the mains plug and fit an appropriate type.

DANGER: The fuse from the cut-off plug should be removed and the cut-off plug destroyed immediately and disposed of in a safe manner.

Under no circumstances should the cut-off plug be inserted elsewhere into a 13A socket outlet as a serious electric shock may occur.

To fit an appropriate plug to the mains lead follow the instructions below:

IMPORTANT: The wires in the mains lead are coloured in accordance with the following code:

Blue: Neutral

Brown: Live

As the colours of the wires in the mains lead of this product may not correspond with the coloured markings identifying the terminals in your plug, proceed as follows:

- The wire which is coloured blue must be connected to the plug terminal which is marked N or coloured black.
- The wire which is coloured brown must be connected to the plug terminal which is marked L or coloured red.

Ensure that neither the brown nor the blue wire is connected to the earth terminal in your three pin plug.

Before replacing the plug cover make sure that:

- If the new fitted plug contains a fuse, its value (rating) is the same as that removed from the cut-off plug.
- The cord grip is clamped over the sheath of the mains lead, and not simply over the lead wires.

IF YOU HAVE ANY DOUBT CONSULT A QUALIFIED ELECTRICIAN.

In the unlikely event of this equipment requiring repair during the guarantee period, you will need to provide proof of date of purchase to the repairing company.
Please keep your invoice or receipt, which is supplied at the time of purchase.

Safety Precautions

This equipment complies with the requirements of Directives 89/336/EEC and 73/23/EEC as amended by 93/68/EEC.

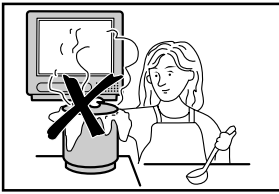

To prevent fire or electrical shock, do not use the TV set in an excessively damp place.

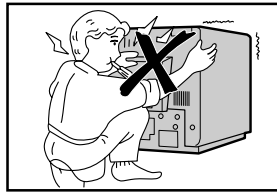

Never remove the back of the cabinet, as there is high voltage inside the TV set. Please call for service.

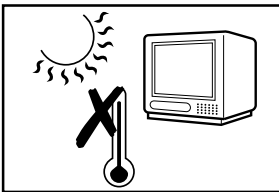

Position the TV set out of direct sunlight and away from heat, as high temperatures can damage the cabinet, CRT, or other electronic parts.

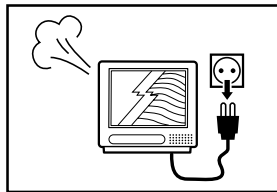

Unplug the power cord from the wall outlet immediately if the TV set begins to make unusual noises or gives off smoke or an odd smell, then call your dealer for service.

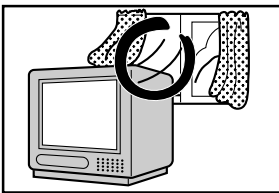

Do not cover the ventilation holes at the back of the TV set, as this can cause fire or other serious problems. Leave an adequate open space behind the TV set for good ventilation.

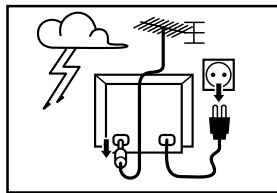

Even if the TV set is turned off, it can still be damaged by lightning striking the mains and/or aerial cables. For this reason, you should always disconnect the TV set from the mains and the aerial cable during thunderstorms.

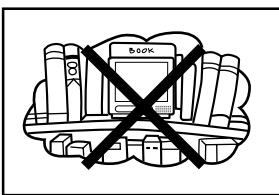

Do not install the TV set in a confined space, such as a bookcase or built-in cabinet.

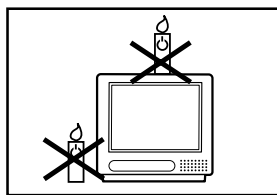

To prevent fire, never place any type of candle or naked flames on the top or near the TV set.



The TV set and cart combination should be moved with care. Quick stops, excessive force, and uneven surfaces may cause the TV set and cart combination to overturn.

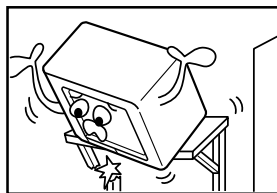

Wall or shelf mounting should follow the manufacturer's instructions, and should use a mounting kit approved by the manufacturer.

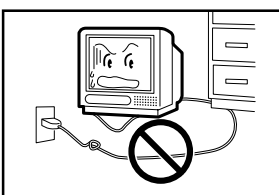

To prevent electrical shock, do not subject the AC power cord to damage by bending or twisting it, or by placing heavy items on top of it. If the AC power cord becomes damaged, unplug it from the wall outlet immediately and call your dealer for service.

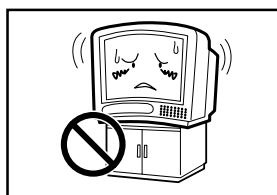

Do place the TV set onto an even stand, table or track whose size is bigger than the TV set. If the TV set is put onto a smaller size or uneven stand, table or track may cause the TV cabinet distort. Do not put or insert anything between the TV set and the stand, table or track.

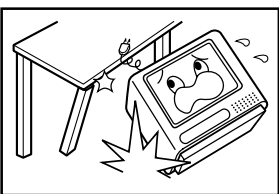

Do not place the TV set on an unstable cart, stand, or table. The TV set may fall, causing serious injury to a child or an adult, and serious damage to the TV set. Use only with a cart or stand recommended by the manufacturer, or sold with the TV set.

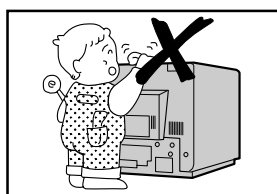

Never insert or drop any metallic or inflammable objects into the ventilation holes of the TV set, this can cause fire, electrical shock or electrical failure. Do not place a flower vase or anything else containing liquid on the TV set, as liquid spilt on the TV set can cause serious problems.

CAUTION: Make sure that the main power is turned off when going out.

Contents

General Information	Channel Setting	Useful Features
Safety Precautions 3	Initial Setting/ Auto Tuning 7	Picture Adjustment 16
Accessories 4	After Initial Setting/ Auto Tuning 7	Timer Setting 17
Remote Control Battery Installation 4	Manual Tuning 8	Child Lock (Channel Block) 19
Installing your TV	Fine Tuning 10	Other Functions
Aerial Connections 5	Skipping Programmes 11	Flashback, Sound Mute 22
Typical Connections 5	Manual Channel Sorting .. 13	TV/VIDEO, Call 23
Location of Controls 6	Channel Sorting (Delete) 14	Teletext Mode 24
	Basic Operation	Reference
	Watching a TV Programme .. 15	Troubleshooting 27
		Specifications 28

Dear SHARP Customer

Congratulations! You are now the proud owner of a SHARP Colour Television Receiver. To ensure proper operation, please read this manual carefully. After reading, keep it in a safe place for future reference.

Accessories

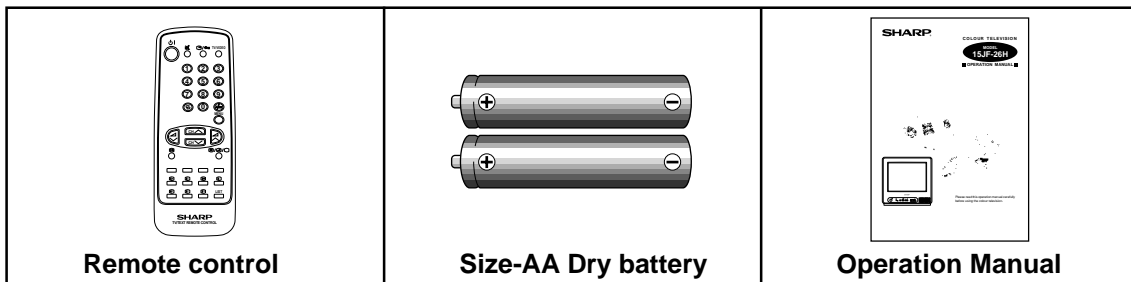

Remote Control Battery Installation

Before using the TV set for the first time, install the supplied dry batteries in the remote control.

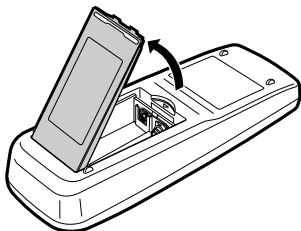

- ① With your thumbnail, pull up the slit as indicated by the arrow to remove the battery cover.

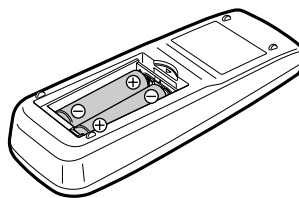

- ② Insert two batteries 1.5 V (size "AA"). Be sure to match the battery \oplus/\ominus terminals with the \oplus/\ominus marks inside the compartment.

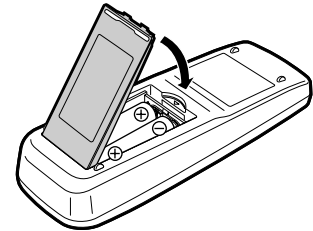

- ③ Close the battery cover.

NOTE

- Remove batteries if weak or if the TV set is not in use for long periods.
- Do not mix old and new batteries.
- Incorrect installation of the batteries may damage the remote control.



Aerial Connections

- To enjoy a clearer picture, we recommend that you use an outdoor aerial. The following is a brief explanation of the types of connection that are used for coaxial:

Aerial Lead: Connect the cable from the aerial to a standard DIN45325 plug (IEC169-2) and plug it into the aerial terminal at the back of the TV set.



75-ohm coaxial cable (round cable)

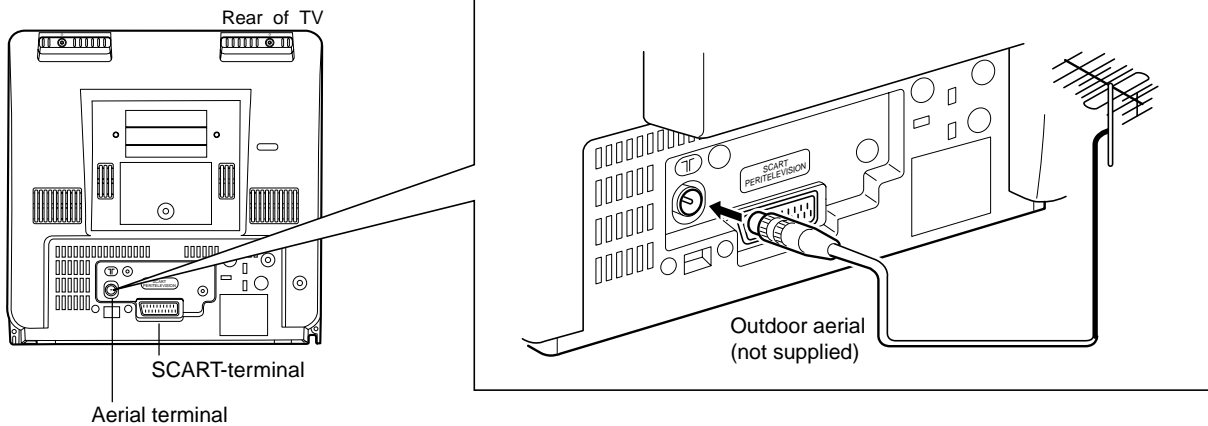

Typical Connections

Enjoy the stunning visuals of a VCR or DECODER by connecting them to this TV set through its Euro-SCART 21-Pin terminal.

Please refer to the Operation Manual of your VCR for details.

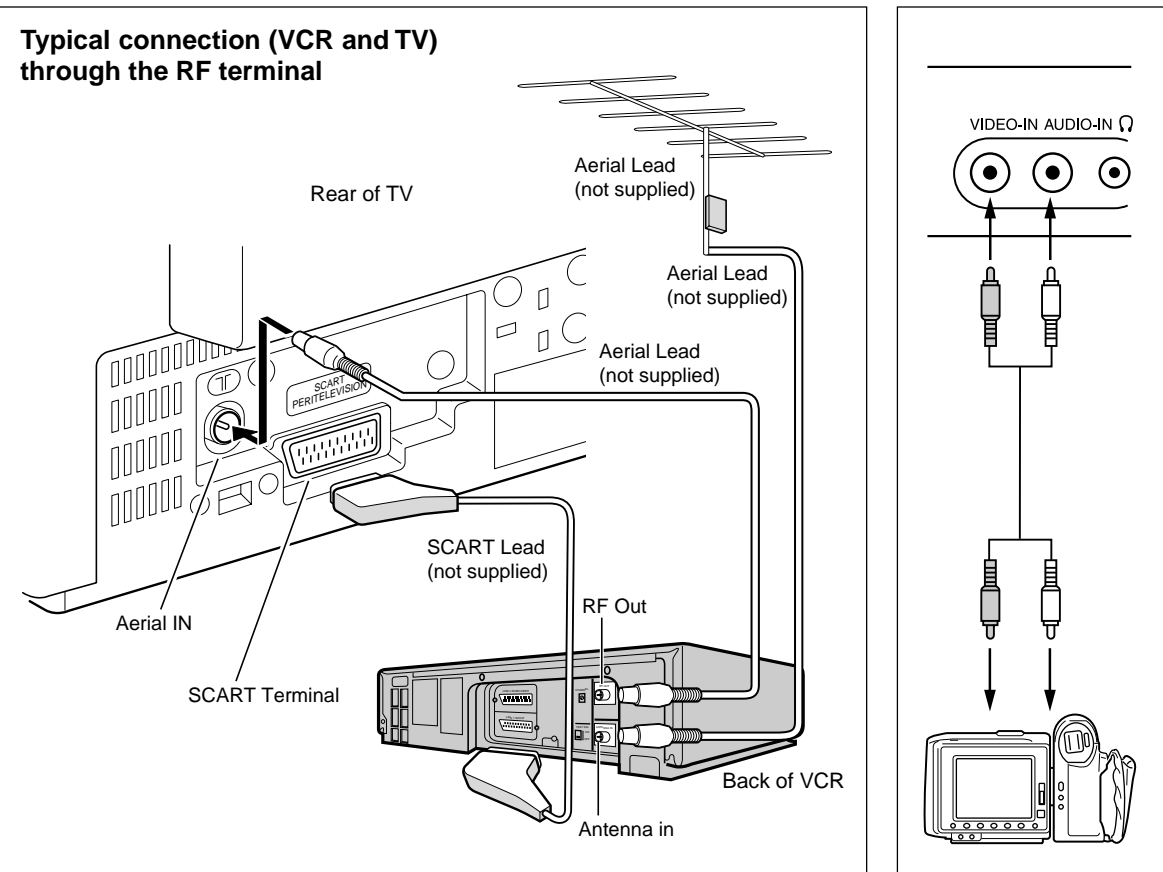



Location of Controls

Remote Control

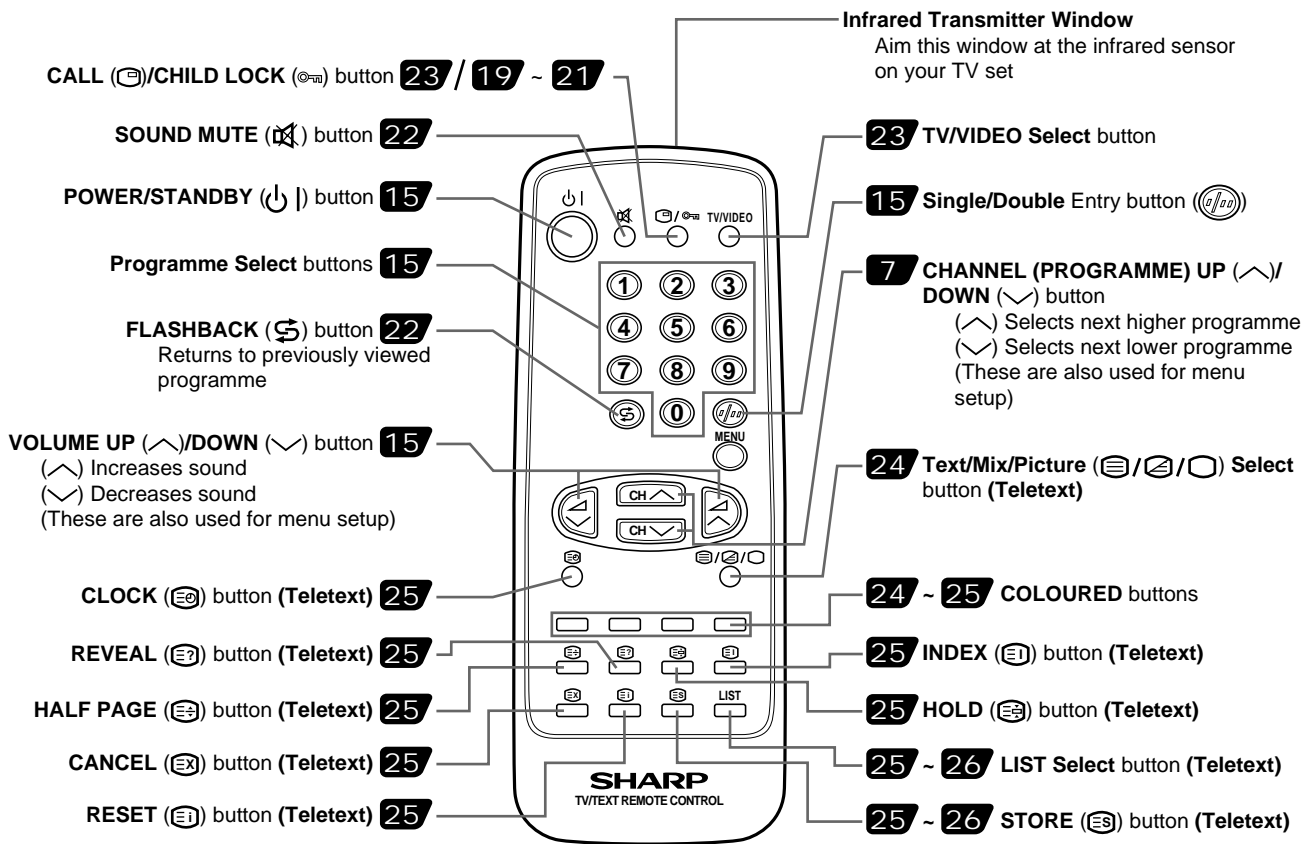

TV Front

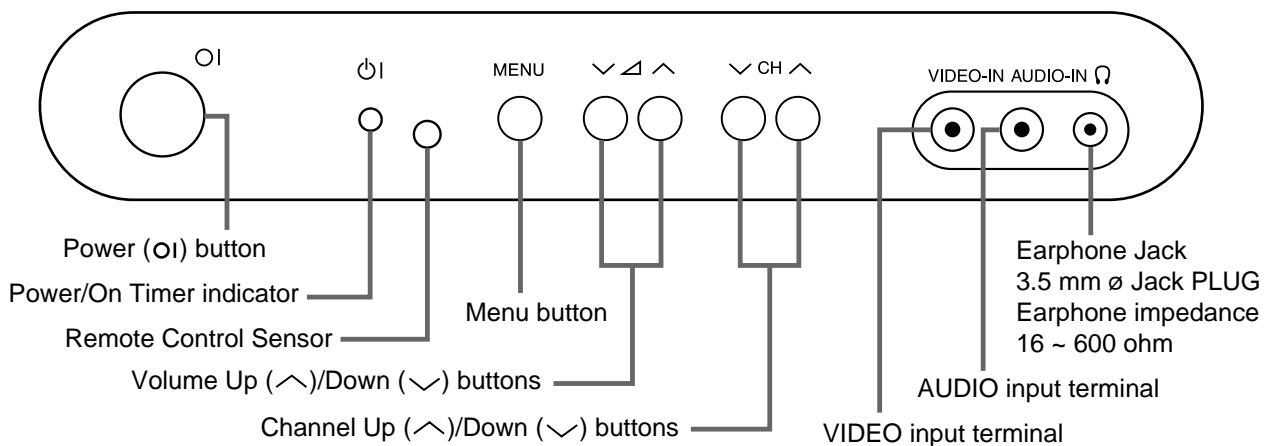



Channel Setting

This function will automatically tune all local channels for you. The following steps are carried out using the remote control.

Initial Setting Auto Tuning

Automatically tunes in and presets receivable TV stations

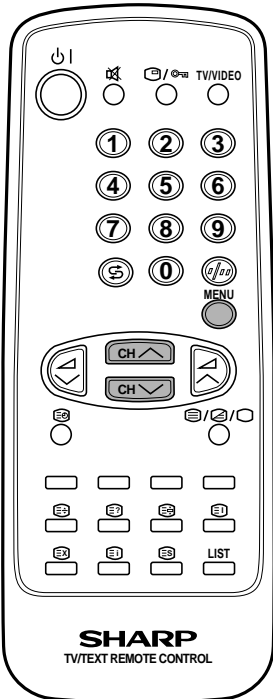

1 Press the Power button on the TV set. When you turn on the TV set for the first time, the screen on the right will appear.

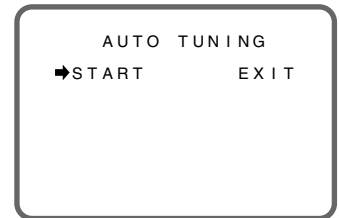

2 AUTO TUNING will start when selecting "START", using or and pressing on the remote control, or pressing on the TV.

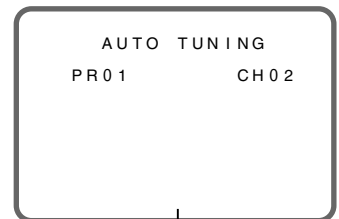

All the TV stations in your area that can be received by the TV set are automatically preset between programme position from 1 to 99.

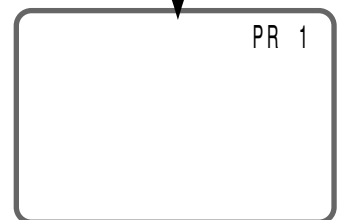

The screen shows whatever is on programme position 1 when full auto channel preset is finished.

NOTE: Make sure to execute AUTO TUNING until tuning is complete. When EXIT has been selected during tuning or when the power has been turned off and turned on again, the AUTO TUNING screen will be displayed.

After Initial Setting Auto Tuning

Automatically tunes in and presets receivable TV stations

1 The AUTO TUNING screen will appear by holding down on the TV set for more than 2 seconds.

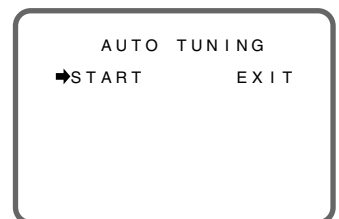

2 Repeat step 2 above (Initial setting).

NOTE

- To stop AUTO TUNING, press on the remote control.
- When AUTO TUNING is not done, select EXIT by using or on the remote control or press on the TV set to return to the TV screen.

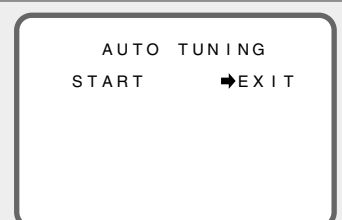

- Make sure to start AUTO TUNING after connecting the antenna, as the AUTO TUNING screen will be displayed when the power is turned on for the first time.
- Make sure to execute AUTO TUNING until tuning is complete. When EXIT has been selected during tuning or when the power has been turned off and then turned on again, the AUTO TUNING screen will be displayed.
- When the Child Lock is set, it is not possible to enter the Tuning mode. This is to make sure that Child Lock is not over-riden by re-tuning the TV set. (To cancel Child Lock, please refer to page 21)



Channel Setting (Continued)

This section describes how to tune your TV set manually and to store channels in the order you prefer. The following steps are carried out using the remote control.

Manual Tuning

Setting a TV station to a desired programme position

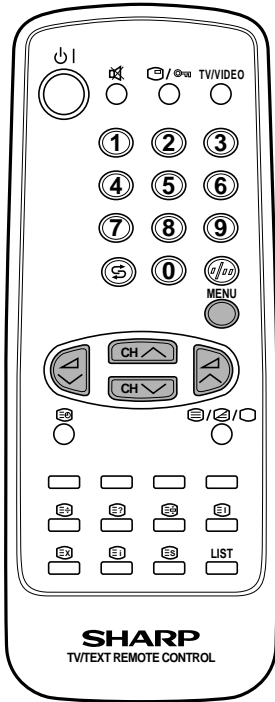

1 Press to call the MAIN menu screen.

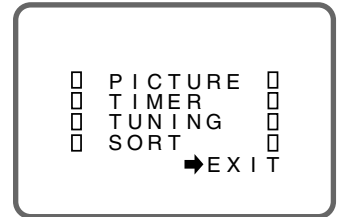

2 Press or to select "TUNING", and press .

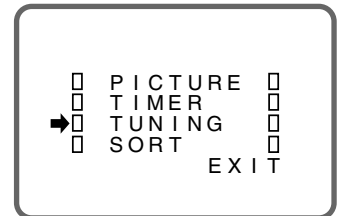

3 Press or to select "PR" position, and select the programme number (1-99) with or .

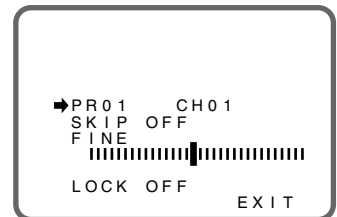

4 Press or to select "CH", and select the channel number with or .

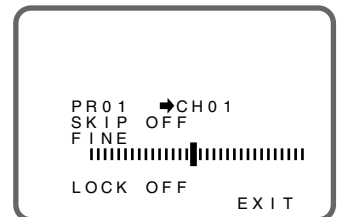

5 Repeat steps 3 and 4 if you wish to set other channels.

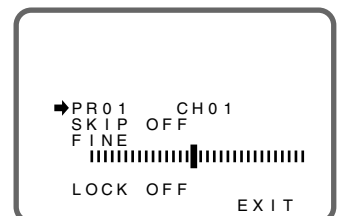



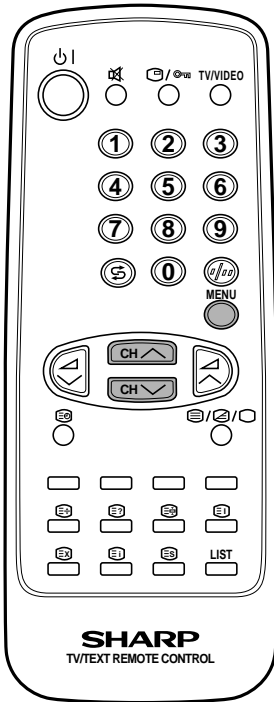

Channel Setting (Continued)

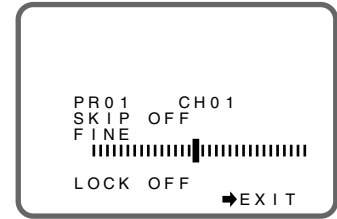

6 Press or to select "EXIT", and press to return to the normal screen.



NOTE

- If there is no sound and the key mark () is displayed after setting the channels, the Child Lock Mode has been activated. To cancel the settings, make sure to set key mark () to OFF.
- If you are using a decoder (premiere Decoder, Canal plus, etc.), please disconnect it before using the tuning "TUNING" and "SORT" menus.



Channel Setting (Continued)

Fine Tuning

This function lets you easily fine-tune the TV set to improve reception and picture quality.

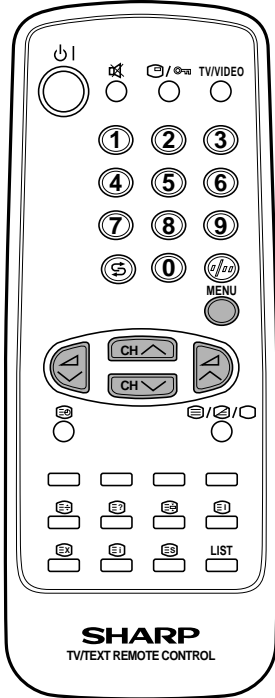

1 Press to call the MAIN menu screen.

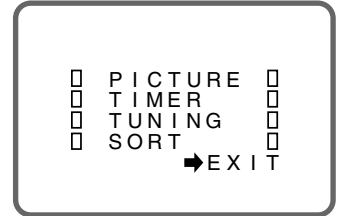

2 Press or to select "TUNING", and press .

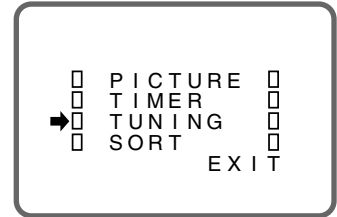

3 Press or to select the "FINE" position.

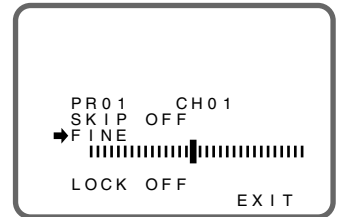

4 Press and hold or until the best tuning position is found.

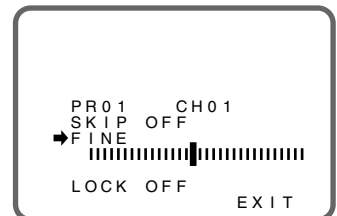

5 Press or to select "EXIT", and press to return to the normal screen.

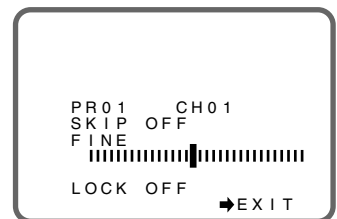



Channel Setting (Continued)

Skipping Programmes

This function lets you skip vacant channels or channels that you never watch when you select channels with or .

Setting Skip

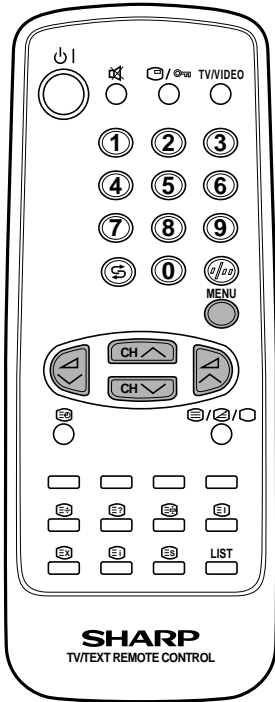

1 Press to call the MAIN menu screen.

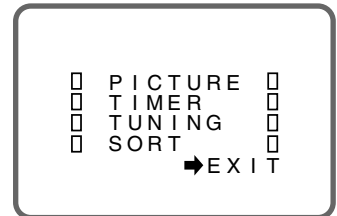

2 Press or to select "TUNING", and press .

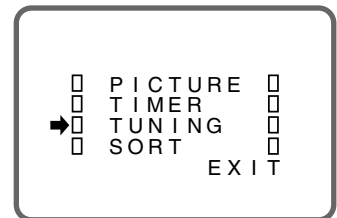

3 Press or to select the "PR" position, and select the programme number (1-99) you wish to skip with or .

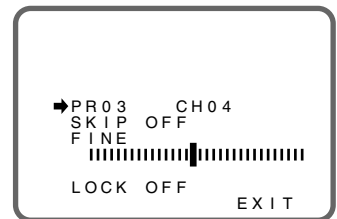

4 Press or to select "SKIP", and press to select "SKIP ON". The programme number will turn from white to red.

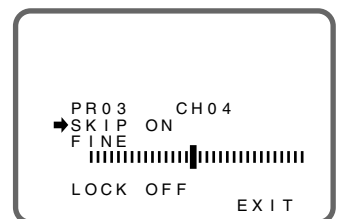

5 Repeat steps 3 and 4 if you wish to skip other programmes.

6 Press or to select "EXIT", and press to return to the normal screen.

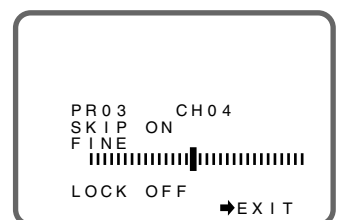



Channel Setting (Continued)

Canceling Skip

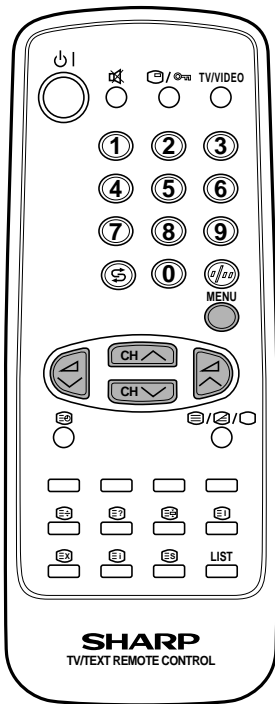

1 Press to call the MAIN menu screen.

```
□ PICTURE □
□ TIMER □
□ TUNING □
□ SORT □
      →EXIT
```

2 Press or to select "TUNING", and press .

```
□ PICTURE □
□ TIMER □
→□ TUNING □
□ SORT □
      EXIT
```

3 Press or to select the "PR" position, and select the programme number (1-99) you wish to cancel skip with or .

```
→PR 01 CH 01
SKIP ON
FINE
████████████████████
LOCK OFF EXIT
```

Select a skipped programme number displayed in red.

4 Press or to select "SKIP", and press to select "SKIP OFF". The displayed programme number will turn from red to white.

```
PR 01 CH 01
→SKIP OFF
FINE
████████████████████
LOCK OFF EXIT
```

5 Repeat steps 3 and 4 if you wish to cancel skipping other programmes.

6 Press or to select "EXIT", and press to return to the normal screen.

```
PR 01 CH 01
SKIP OFF
FINE
████████████████████
LOCK OFF →EXIT
```



Channel Setting (Continued)

Manual Channel Sorting

When moving channel 20 from preset channel 12 to preset channel 30, follow the steps below:

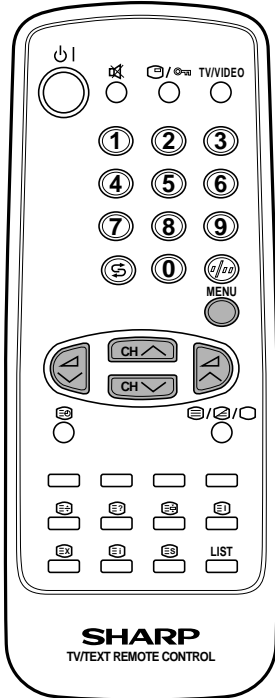

- 1** Press to call the MAIN menu screen.
Press or to select "SORT", and press .

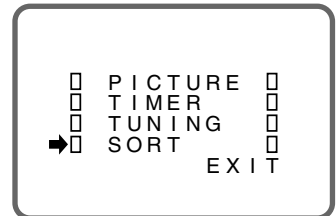

- 2** Select channel 20 of the preset channel 12 field with , , or , and press .

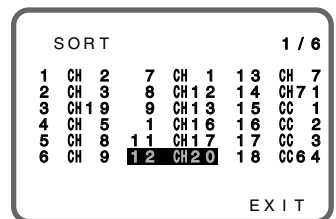

- 3** Move the cursor to "MOVE" with , , or , and press .

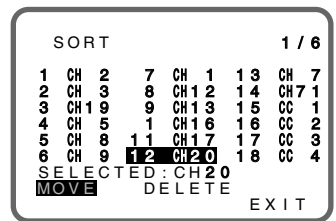

- 4** Move to the next screen with , , or and select preset channel 30.

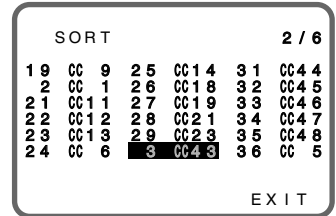

- 5** Pressing will insert channel 20 in the preset channel 30 field. Preset channels over preset channel 31 will be automatically sorted.

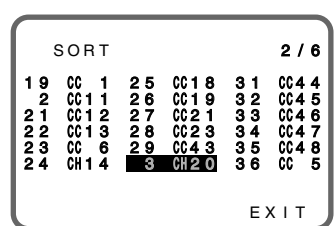

- 6** Select "EXIT" with , , or , and press to return to the normal Screen.

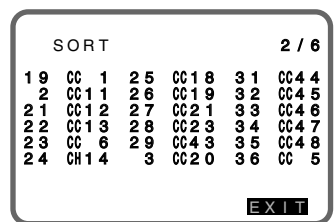



Channel Setting (Continued)

Channel Sorting (Delete)

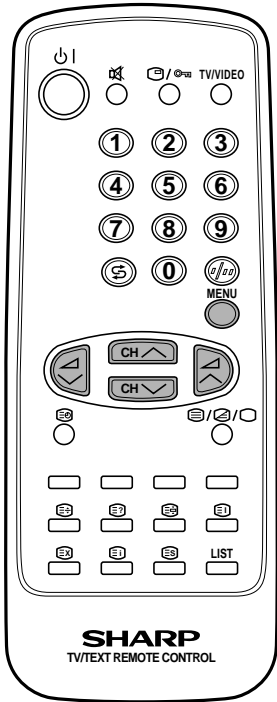

1 Press to call the MAIN menu screen.
Press or to select "SORT", and press .

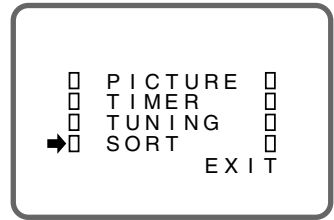

2 Select channel 13 in the preset channel 9 field with , , , or , and press .

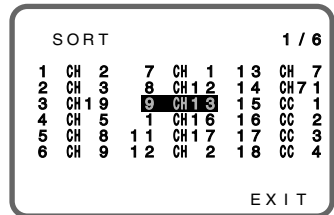

3 Select "DELETE" with , , , or , and press .

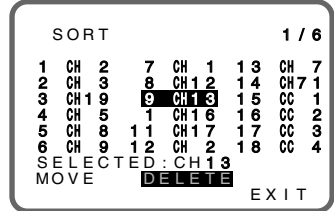

4 Pressing will delete channel 13 in the preset channel 9 field and replace it by channel 16.

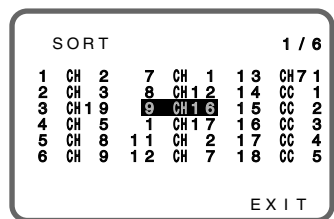

5 Select "EXIT" with , , , or , and press to return to the normal Screen.

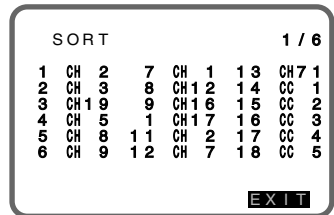

NOTE

If you are using a decoder (Premiere Decoder, Canal Plus, etc.), please disconnect it before using the tuning "TUNING" and "SORT" menus.



Basic Operation

Watching a TV Programme

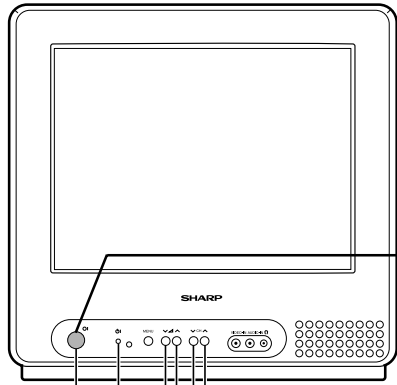

POWER button
POWER indicator
CHANNEL UP or DOWN button
VOLUME UP or DOWN button

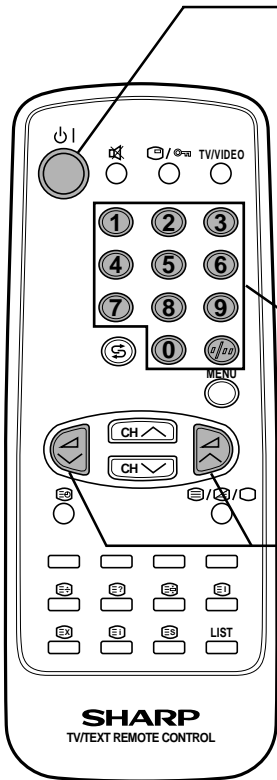

Preparation ▶ Turning on the power on the TV set.
Press

If a picture appears on the screen, go to step 2.
If a picture does not appear on the screen, go to step 1.

1 Turn on the power by pressing .
A picture appears on the screen.

PR 1

2 Select the programmes.

Example:
When selecting programme position 5

When selecting programme position 23
 → →

PR ..

→

PR 2·

→

PR 23

PR 5

3 Adjust the volume.

Decreases the volume

Increases the volume

PR 1

NOTE
If you go away on a trip or will not be at home for a considerable length of time, as a safety precaution, please unplug the power cord from the wall outlet.

Picture Adjustment

Adjusting the Picture

Picture quality (CONTRAST, COLOUR, BRIGHTNESS, SHARPNESS) is adjustable in this menu.

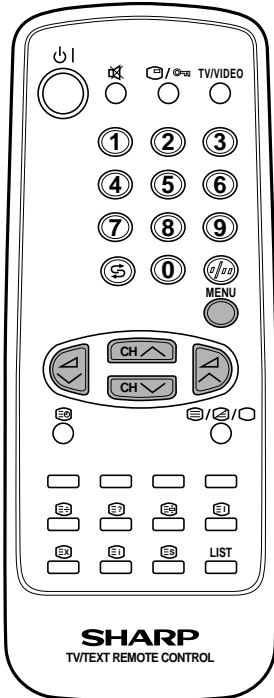

- 1** Press to call the MAIN menu screen.

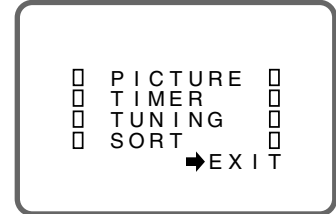

- 2** Press or to select "PICTURE", and press .

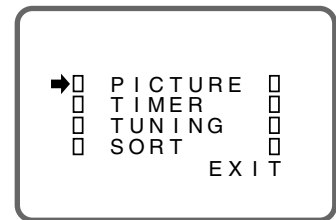

- 3** Press or to select the items to adjust.

Selected item	
	CONTRAST
	COLOUR
	BRIGHTNESS
	SHARPNESS
TINT	TINT
N	NORMAL

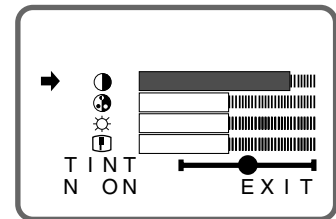

- 4** Adjust the picture quality to your liking with or .

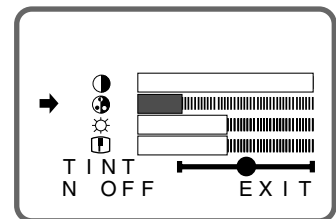

- 5** Repeat steps 3 and 4 above to adjust other items.

- 6** By selecting "N" you can reset the picture parameters to the factory setting.

Press to restore the factory setting "N ON" mode.

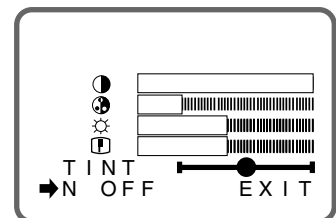

- 7** You can clear the on-screen display by selecting "EXIT" with

or , and press .

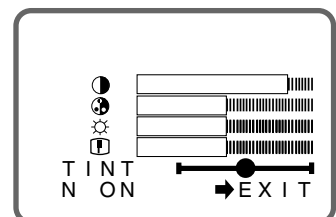



Timer Setting

ON Timer

Automatically turns the power on after the set time has passed.

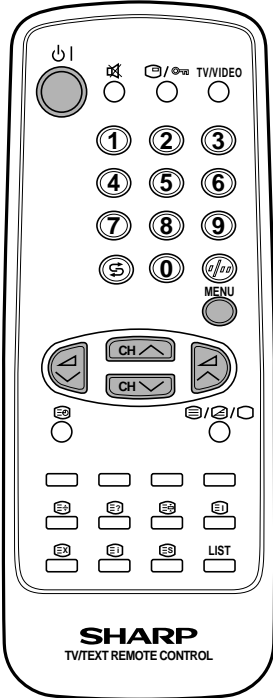

1 Press to call the MAIN menu screen.

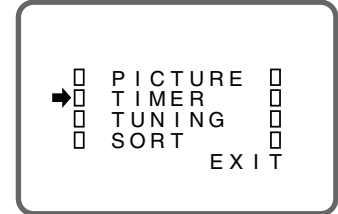

2 Press or to select "TIMER", and press .

3 Press or to select "ON" mode.

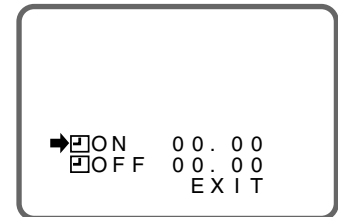

4 Press or to set the time. (from 10 min. to 12 hour 50 min., in 10 min. increments)

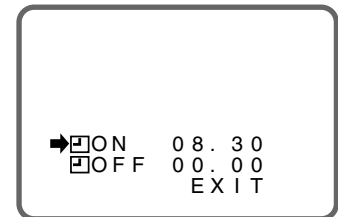

5 Press to set the TV set into Standby mode. The Power indicator flashes in red. When the preset time (in the above example, 8 hours and 30 minutes) has passed, the power turns on and a picture appears on the screen.

NOTE

- When the TV set is in the Standby mode, the ON Timer indicator remains flashing in red.
- As a safety precaution, in case nobody is at home when the TV set turns on automatically, the TV set will turn off itself automatically within 120 minutes; any button of the remote control should be pressed, if it is to remain turned on.
- In the event of a power cut, disconnection of the plug, or when the TV set is turned off with the Power button on the TV set, all the data in the ON Timer will be cancelled.
- The TIMER settings will remain if you exit the TIMER setting screen using EXIT after setup.



Timer Setting (Continued)

OFF Timer

Automatically turns the power off after the set time has passed.

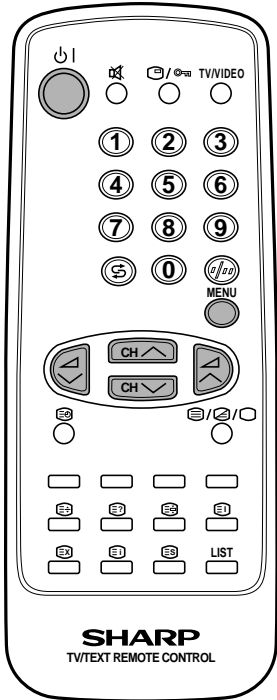

1 Press to call the MAIN menu screen.

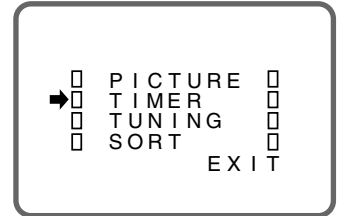

2 Press or to select "TIMER", and press .

3 Press or to select "OFF" mode.

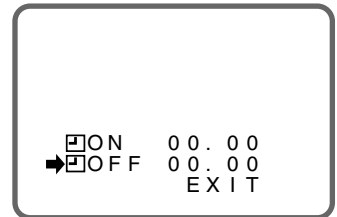

4 Press or to set the time. (from 10 min. to 12 hour 50 min., in 10 min. increments)
The timer starts to count down.

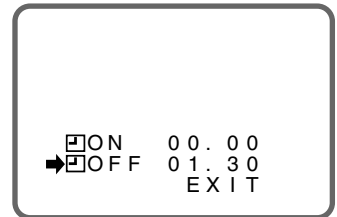

5 After setting the time, select "EXIT" with or and press .

When the preset time (in the above example, 1 hour and 30 minutes) has passed, the TV set turns to Standby mode.

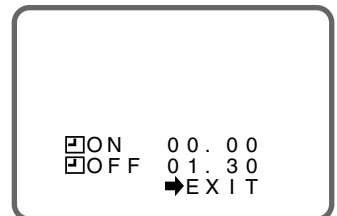

NOTE

- In the event of a power cut, disconnection of the plug, or the TV set is turned off with the Power button on the TV set, all the data on the OFF Timer will be cancelled.
- The TIMER settings will remain if you exit the TIMER setting screen using EXIT after setup.



Child Lock (Channel Block)

You can lock a TV channel to prevent unsupervised TV viewing by following these procedures:

Setting Child Lock

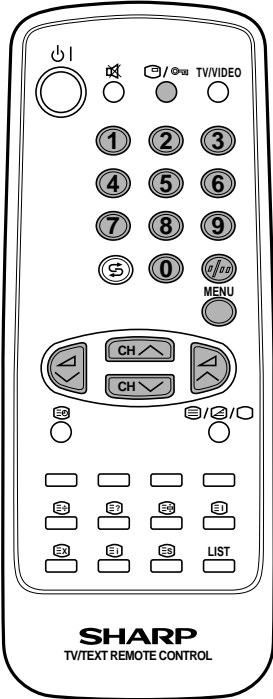

1 Press **MENU** to call the MAIN menu screen.

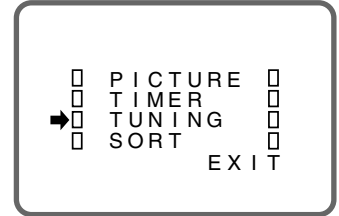

2 Press **CH** or **CH** to select "TUNING" and press **MENU**.

3 Select the programme you want to lock with **CH** or **CH**. (You can also select the programme with the 0-9 digit buttons.)

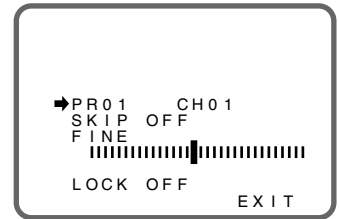

4 Press **CH** or **CH** to select "LOCK ON" and press **MENU**.

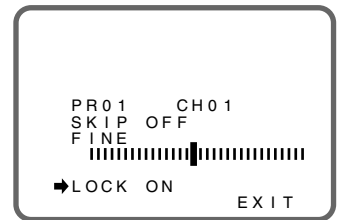

5 Repeat steps 3 and 4 if you wish to lock other programmes.

6 Press **CH** or **CH** to select "EXIT" and press **MENU**.

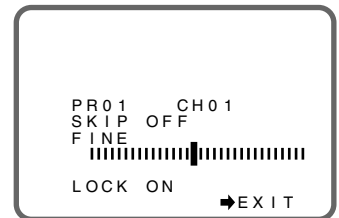

NOTE

- You can also block the SCART connection.
- If you want to set Child Lock for the channel using a decoder (Premiere Decoder, Canal Plus, etc.), you also need to set Child Lock in the "SCART" programme mode.

CAUTION

- When you select a locked channel, the TV picture will be blue and the mark "🔒" appears on the screen.
- Press **MENU** to unlock the channel.
- Since the remote control is the "Key" to unlock Child Lock, you must remember not to let the remote control out of your supervision.



Child Lock (Continued)

Opening Child Lock

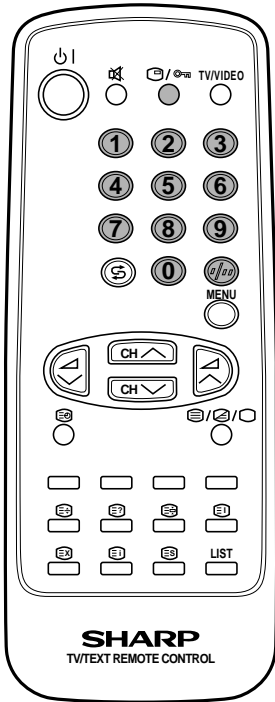

Watching a programme position set with the Child Lock.

- 1** Select the child locked programme position.

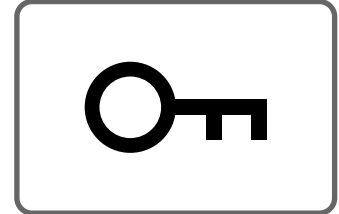

- 2** Hold down  for more than 2 seconds. The picture of the child locked programme is displayed.





Child Lock (Continued)

Cancelling Child Lock

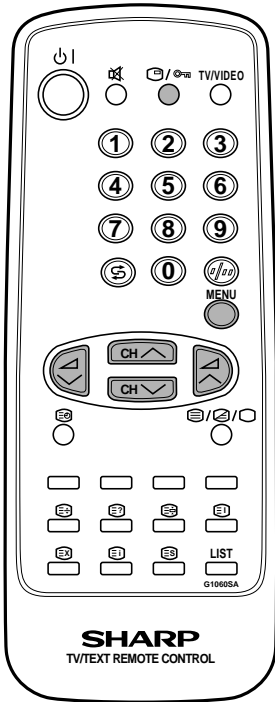

Releasing the Child Locked programme.

1 Select the child locked programme position.

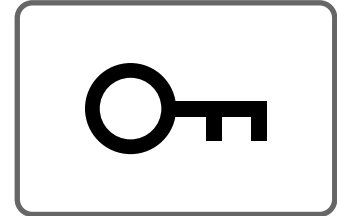

2 Press **MENU** to call the MAIN menu.

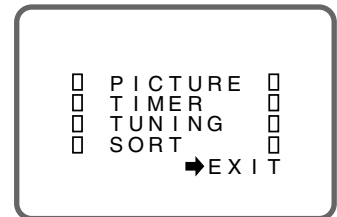

3 Press **CH** or **CH** to select "TUNING" and press **MENU**.

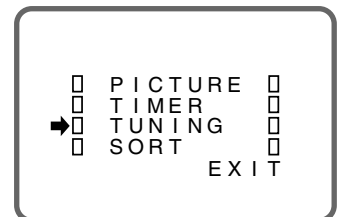

4 When the Child Lock symbol reappears on the screen, press and hold down **TV/VIDEO** for 4 seconds to enter the Fine Tuning menu.

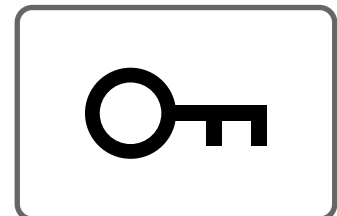

5 Tuning screen is displayed. Press **CH** or **CH** to select "LOCK OFF" by and press **MENU**.

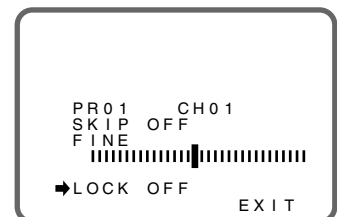

6 If you wish to unlock other locked programmes, choose the locked programme position, and then repeat step 5.

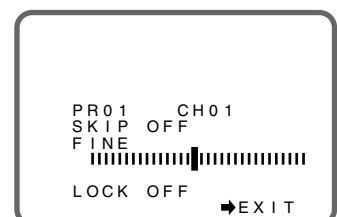

7 Press **RIGHT** or **LEFT** to select "EXIT" and press **MENU**.



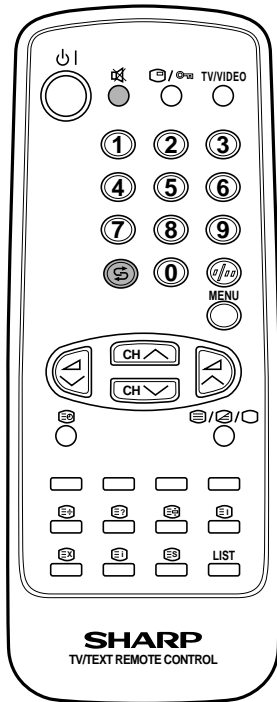

Other Functions



Flashback

Switches back to the channel you were watching just before the current programme.

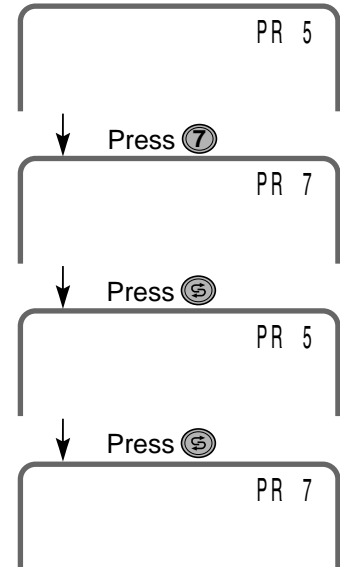

Press .
The channel previously viewed returns to the screen.

Example:
If  is pressed, after switching from channel 5 to channel 7, the programme will change to that of channel 5.
Press  again to return to the programme of channel 7.



Sound Mute

Mutes the sound.

1 Press .
The symbol "" appears on the screen, and the sound is silenced.

2 Press  again.
The sound is turned on again.

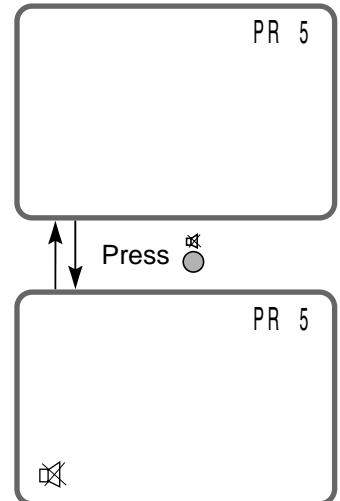



Other Functions (Continued)

TV/VIDEO

Switches between TV broadcasts and AV input programmes.

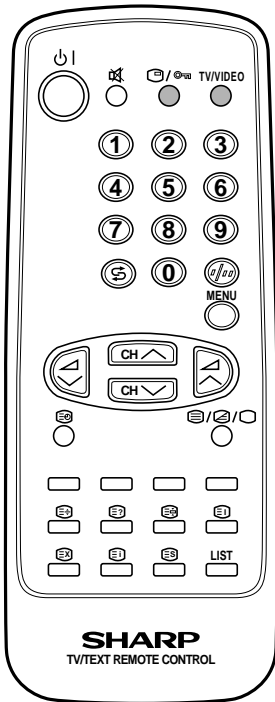

Each time you **press** , the input toggles between SCART, FRONT and TV programmes.

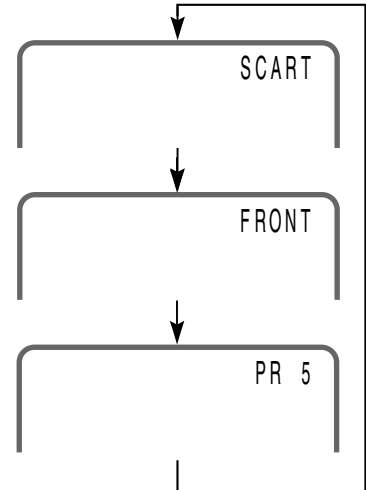

Call

Displays the current programme number, the timer and other settings on the screen.

1

Press .

The time remaining for the ON Timer, OFF Timer and the Programme number appears on the screen.

(When no Timer is set, nothing appears on the screen).

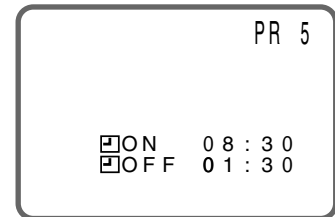

2

Press  once again.

The programme number, ON Timer, and OFF Timer display disappears and the screen returns to the normal screen.



Teletext Mode

Teletext is an information service, organised like a magazine, provided by some television stations in addition to regular television broadcasting.

Basic Operation

Switching ON, selecting a page number and switching OFF the Teletext.

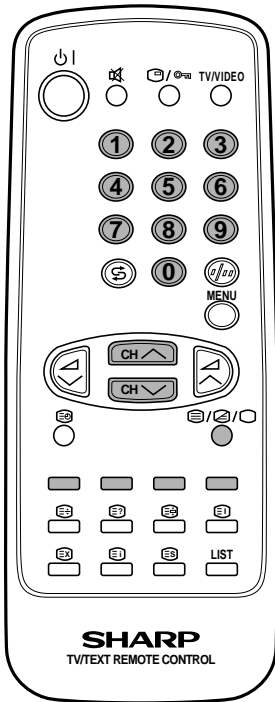

- 1** Select the TV channel which is broadcasting the Teletext programme you would like to watch.
- 2** Press to select the TELETEXT Mode.
- 3** Enter three digits using the 0-9 digit buttons to select a page number.
(/ can also be used.)
- 4** Press to superimpose a Teletext broadcast onto the current TV programme screen (MIXED Mode).
- 5** Press to exit the TELETEXT Mode.

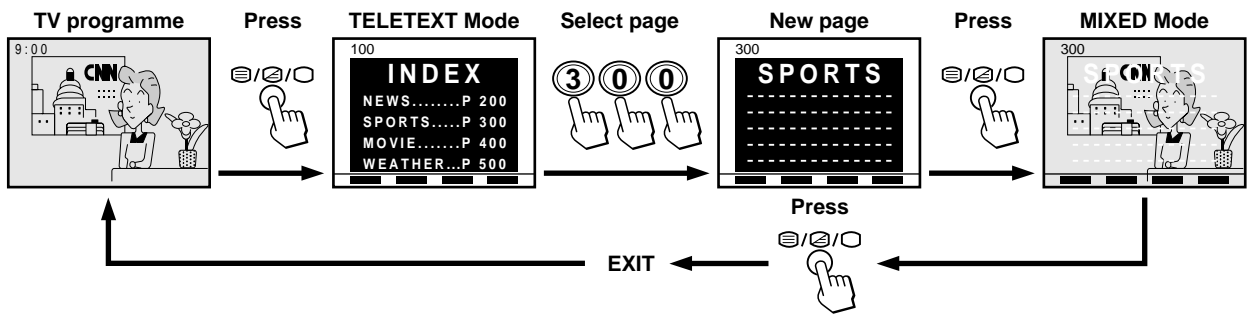

Fast Page Selection

- 1** Select the TV channel which is broadcasting the Teletext programme you would like to watch.
- 2** Press to select the TELETEXT Mode.
- 3** To recall a page number displayed in the coloured brackets, simply press the corresponding coloured button .



Teletext Mode (Continued)

Other Teletext Features

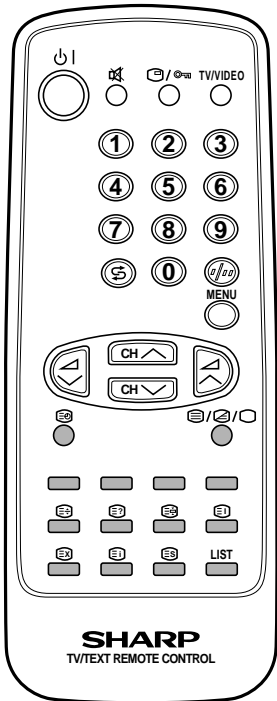

HALF PAGE button:

Press to magnify the upper/lower half of the Teletext page.



REVEAL button:

Press to reveal or hide information such as the answer to a quiz.



RESET button:

Press to return to TV mode.



LIST Select button:

Press to change the system:
FLOF ↔ LIST Mode [1].



HOLD button:

Press to hold or cancel the hold on the current page.



INDEX button:

Press to return to index page.



STORE button:

Press to store in the memory the page numbers in the LIST Mode [1].



COLOURED buttons:

Press the corresponding coloured button, to recall a page displayed in the coloured brackets.



[1] More information on "How to Operate Page Memory" (page 26).

CLOCK button:

In TV Mode: Pressing this button when the TEXT data is received, the real time information will appear on the screen.

In TELETEXT Mode: When a selected Teletext page has hidden subpages or timed pages, these pages can be seen in the following manner:

- 1 Press . <<SUBPAGE: - - - >> will be displayed on the screen.
- 2 Enter 4-digit numbers corresponding to the desired subpage, e.g. 0021 for subpage number 21.
- 3 Wait until the page appears.



NOTE: You can use this button together with . This means that you can view the main TV picture until the subpage has been found. The on screen icon at the top left side of the screen will change when the subpage has been found.

Press to view the subpage.

CANCEL button:

Cancel the Teletext information and restores the TV picture. is shown on the screen. The TV programme cannot be changed while in Teletext/Cancelled mode. When a change takes place in the Teletext information, the upper time of the cancelled page or some other indication of special pages is shown on the screen.

To restore the Teletext, press .



NOTE: This button can be used together with while waiting for subpages to appear.



Teletext Mode (Continued)

Teletext operation - LIST Mode -

How to Operate Page Memory

Your TV has 64 Teletext page number memories for fast recall of Teletext information. Four Teletext page numbers can be stored in each position in programme positions 1 through 15; a total of 60 pages. Only one programme with 4 page numbers can be stored in programme positions 16 through 99, SCART and FRONT. If you try to store more than 4 page numbers in a programme position between 16 and 99, SCART and FRONT, the previously stored page numbers will be erased.

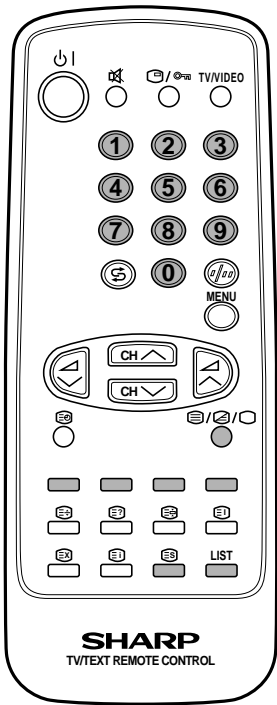

- 1** Select the programme number into which you want to store Teletext page numbers.
- 2** Press to select the TELETEXT Mode.
- 3** Press to change from FLOF system to LIST Mode.
- 4** Press a coloured button corresponding to the coloured brackets on the screen for page number storage.
- 5** Enter the Teletext page number using the 0 ~ 9 digit buttons (enter three digits).
- 6** Repeat steps 4 and 5 until the numbers for the desired pages have been entered.
- 7** Press for more than two seconds to store the page numbers you wish to store in memory. "STORE" appears on the screen.
- 8** Press twice to exit the TELETEXT Mode.

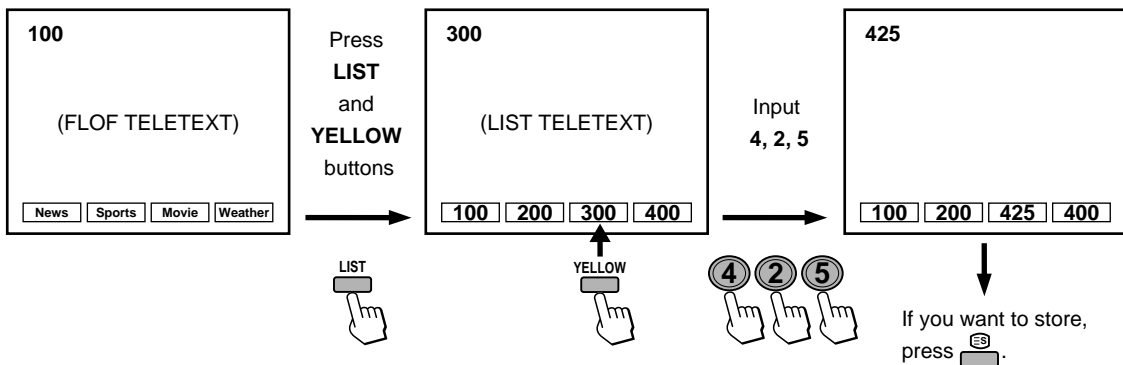

Page Selection - LIST Mode -

- 1** Select the appropriate programme channel.
- 2** Press to select the TELETEXT Mode.
- 3** Press to change from FLOF system to LIST Mode.
- 4** To recall a page number displayed in the coloured brackets, simply **press** the corresponding coloured button.



Troubleshooting

If the fault cannot be corrected by using this guide, remove the mains plug from the wall socket and contact the dealer or supplier from whom it was purchased. Where this is not possible, please visit our web-site at www.sharp.co.uk/support. Customers without internet access may telephone 08705 274277 during office hours (or (01) 676 0648 if telephoning from Ireland).

Certain replacement parts and accessories may be obtained from our Main Parts Distributor, who can be contacted on the following numbers:

Willow Vale Electronics Ltd.

0121 766 5414 and 0161 205 7531

In the unlikely event of this equipment requiring repair during the guarantee period, you will need to provide proof of the date of purchase to the repairing company. Please keep your invoice or Receipt, which is supplied at the time of purchasing.

Quick Service Check List	Possible Causes/Solutions											
	Try a new channel to check for possible station trouble	The TV set not plugged in Outlet power OFF	Power button of the TV set not on	Antenna not connected to terminal at the back of the TV set	If outside antenna is used, check for broken wires	Check for local interference	Turn off the TV set by pressing the Power button on the TV set, then turn on again after a minute	Adjust COLOUR control	Check batteries in the Remote Control	Try fine tuning to correct	Check if the Brightness or Contrast setting in Picture Adjustment might be set to the minus side.	Increase the volume
Remote control does not work		●	●				●		●			
Bars on screen					●	●						
Picture distorted	●				●					●		
Picture rolls vertically	●				●	●						
No colour	●			●	●			●		●		
Poor reception on some channels	●			●	●	●						
Picture weak	●			●	●			●		●		
Picture lines or streaks	●				●	●						
Picture ghosting	●			●	●	●						
Picture blurred	●				●					●		
Sound OK, picture poor	●			●	●	●		●		●	●	
Picture OK, sound poor	●					●						●
No picture or sound	●	●	●	●	●		●				●	●

This TV set is equipped with a microprocessor. Its performance could be adversely affected by external electrical noise or interference. If this should happen, unplug the TV set and plug it in again after a few minutes.

Specifications

Model	15JF-26H
1. Receiving Broadcast Standard	CCIR TV Standard System PAL I
2. Receiving System	Colour System: PAL Field Frequency: PAL 50/60 Hz Capability
3. Reception Channels	VHF: A-J CH UHF: E 21 - E 69 CH CATV: S1 - S20, S21 - S41 (Hyper)
4. Power Source	AC220V-240V, 50Hz
5. Power Consumption at 240V AC 50Hz	37 W
6. Power Consumption at Standby	3 W
7. Audio Output (MPO)	2 W
8. Dimensions (approx.)	Width: 379 mm Height: 376 mm Depth: 396 mm
9. Viewing Area (diagonal measurement)	36 cm (15")
10. Weight (approx.)	12 Kg
11. Internal Speaker	9 cm × 5 cm Oval
12. Antenna Input Impedance	75 ohms Unbalanced
13. Safety	CE - MARK, BEAB
14. EMC	EN61000-3-2, EN61000-3-3, CE - MARK

Design and specifications are subject to change without notice.

Euro-SCART 21-Pin Terminal

For greater A/V enjoyment, various audio and video devices may be connected via the Euro-SCART 21-Pin Terminal.

For example, one can revel in the stunning visuals from a VCR and the dynamic sounds of an audio system. For your interest, here is just one example of an integrated A/V system.

21-Pin Euro-SCART

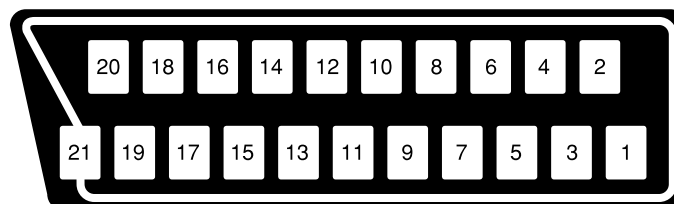

- | | | |
|---------------------------|------------------------|--------------------------------------|
| 1. Audio right output | 8. Audio-video control | 15. Red input |
| 2. Audio right input | 9. Earth for green | 16. Red/Green/Blue control |
| 3. Audio left output | 10. Not used | 17. Earth for video |
| 4. Common earth for audio | 11. Green input | 18. Earth for Red/Green/Blue control |
| 5. Earth for blue | 12. Not used | 19. Video output |
| 6. Audio left input | 13. Earth for red | 20. Video input |
| 7. Blue input | 14. Not used | 21. Plug shield |

NOTE

Audio: Mono Input/Output.

SHARP®

**SHARP ELECTRONICA
ESPAÑA, S.A.**

SHARP ELECTRONICS (U.K.) LTD.

**Sharp House, Thorp Road, Newton Health,
Manchester M40 5BE**